

# Computer Architecture

## External Memory

**ARASH HABIBI LASHKARI**  
**( April- 2010)**

# Types of External Memory

- Magnetic Disk
  - RAID
  - Removable
- Optical
  - CD-ROM
  - CD-Recordable (CD-R)
  - CD-R/W
  - DVD
- Magnetic Tape

# Magnetic Disk

- Disk substrate coated with magnetizable material (iron oxide...rust)
- Substrate used to be aluminium
- Now glass
  - Improved surface uniformity
    - Increases reliability
  - Reduction in surface defects
    - Reduced read/write errors
  - Lower flight heights (See later)
  - Better stiffness
  - Better shock/damage resistance

# Read and Write Mechanisms

- Recording & retrieval via conductive coil called a head
- May be single read/write head or separate ones
- During read/write, head is stationary, platter rotates
- Write
  - Current through coil produces magnetic field
  - Pulses sent to head
  - Magnetic pattern recorded on surface below
- Read (traditional)
  - Magnetic field moving relative to coil produces current
  - Coil is the same for read and write
- Read (contemporary)
  - Separate read head, close to write head
  - Partially shielded magneto resistive (MR) sensor
  - Electrical resistance depends on direction of magnetic field
  - High frequency operation
    - Higher storage density and speed

# Inductive Write MR Read

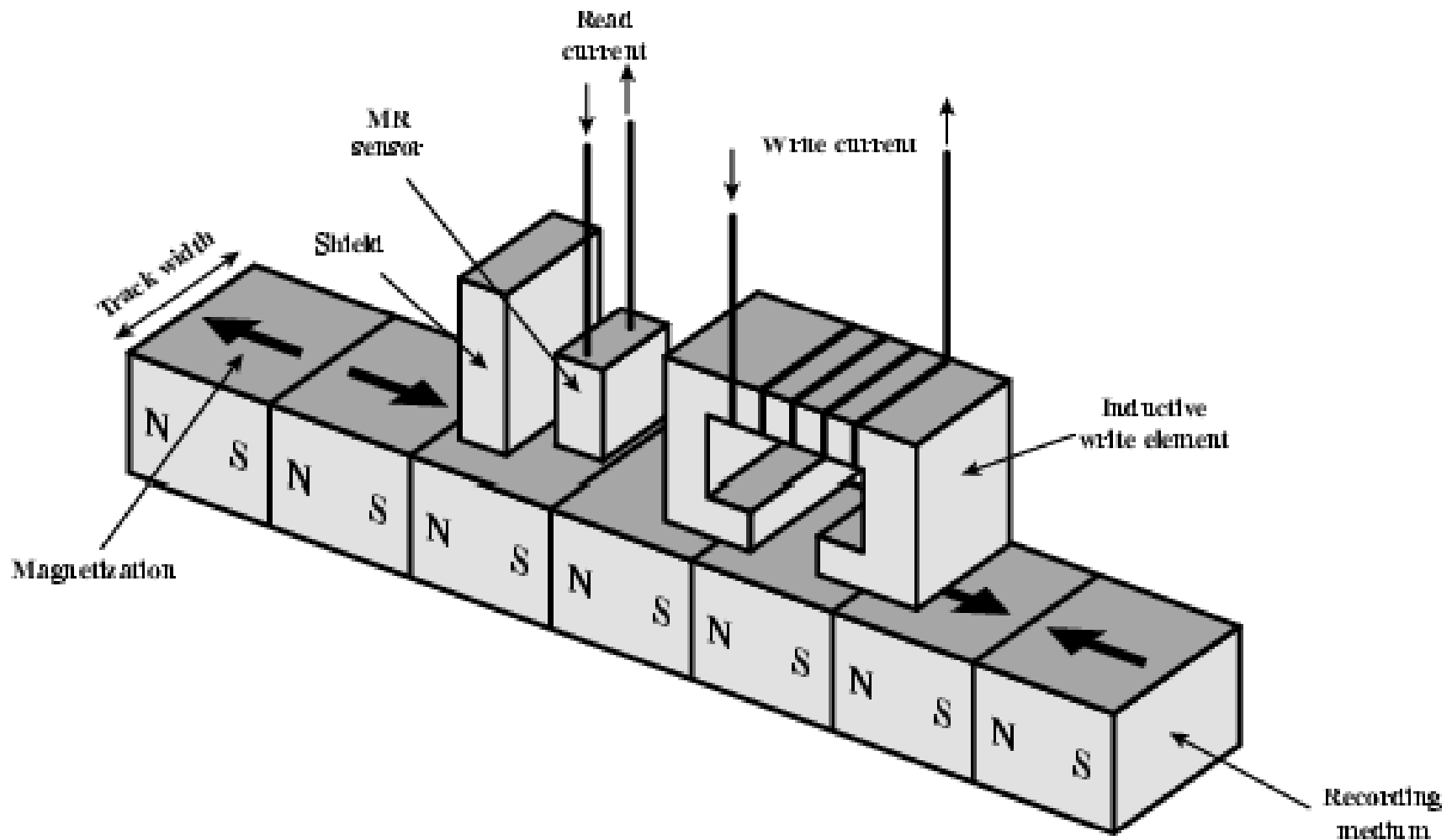

# Data Organization and Formatting

- Concentric rings or tracks
  - Gaps between tracks
  - Reduce gap to increase capacity
  - Same number of bits per track (variable packing density)
  - Constant angular velocity
- Tracks divided into sectors
- Minimum block size is one sector
- May have more than one sector per block

# Disk Data Layout

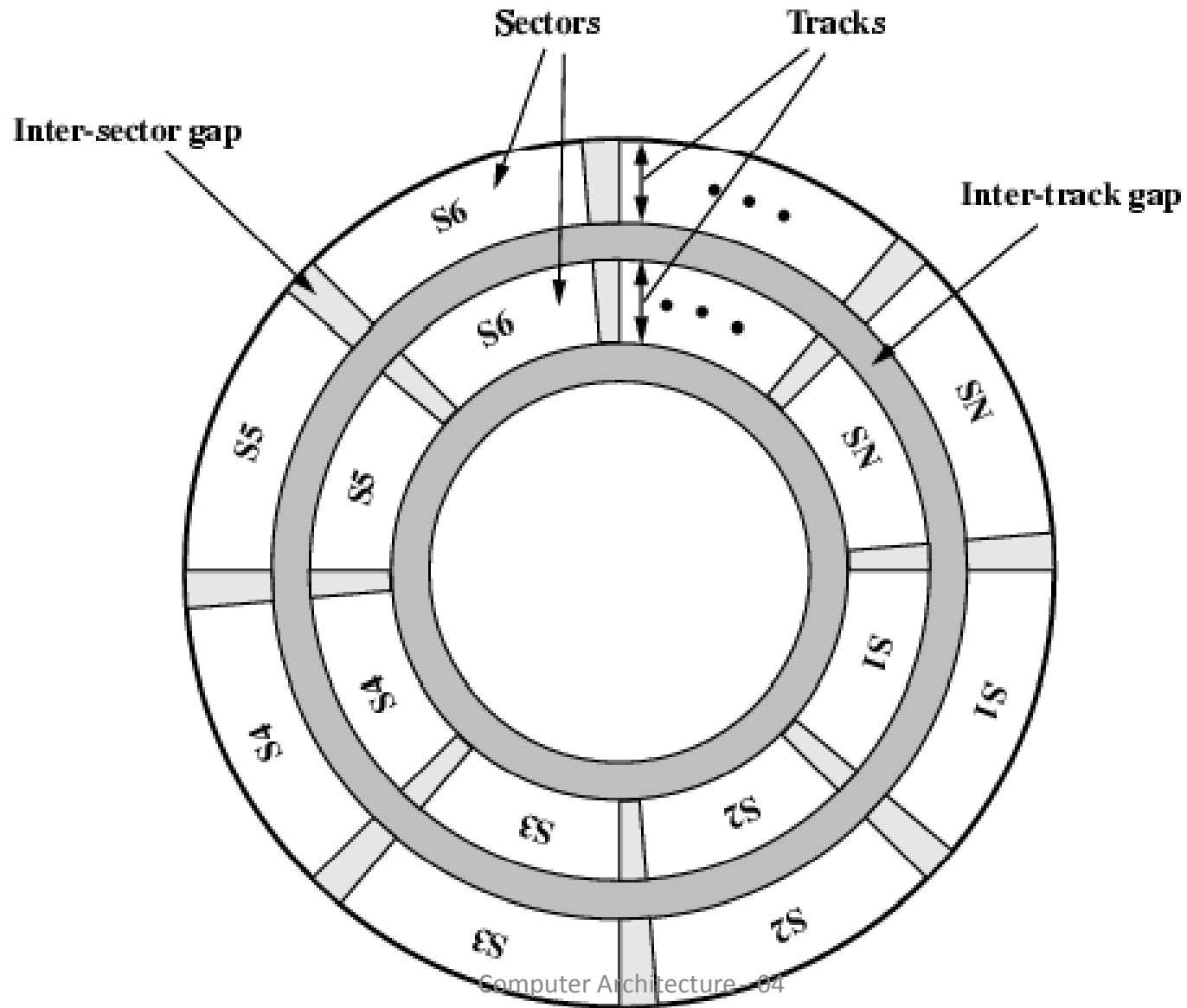

# Disk Velocity

- Bit near centre of rotating disk passes fixed point slower than bit on outside of disk
- Increase spacing between bits in different tracks
- Rotate disk at constant angular velocity (CAV)
  - Gives pie shaped sectors and concentric tracks
  - Individual tracks and sectors addressable
  - Move head to given track and wait for given sector
  - Waste of space on outer tracks
    - Lower data density
- Can use zones to increase capacity
  - Each zone has fixed bits per track
  - More complex circuitry



# Disk Layout Methods Diagram

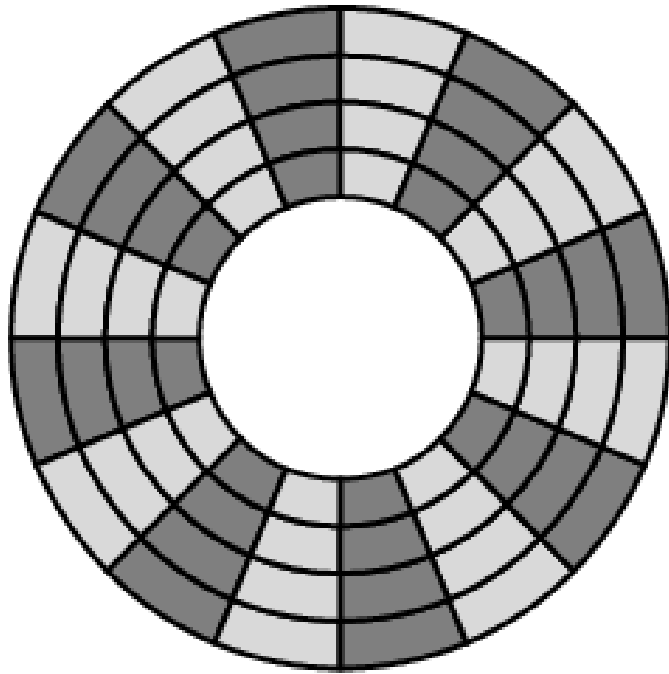

**(a) Constant angular velocity**

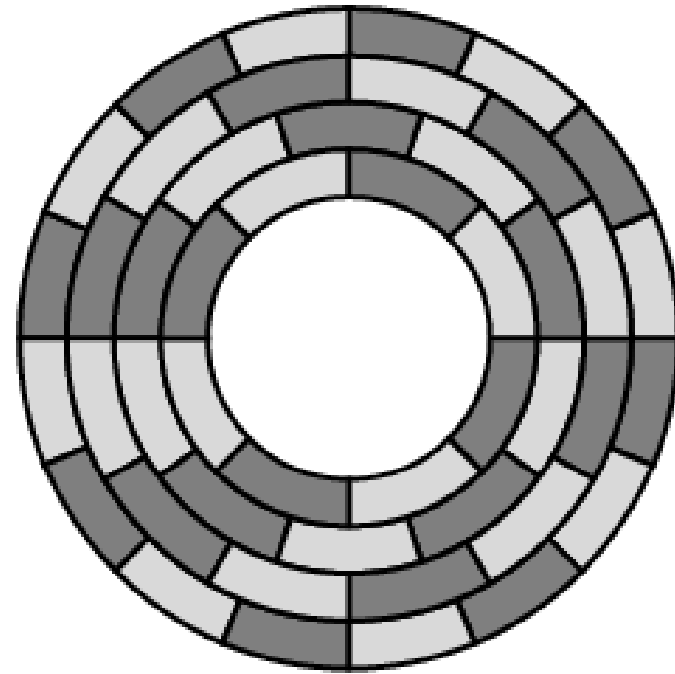

**(b) Multiple zoned recording**

# Finding Sectors

- Must be able to identify start of track and sector
- Format disk
  - Additional information not available to user
  - Marks tracks and sectors

# Characteristics

- Fixed (rare) or movable head
- Removable or fixed
- Single or double (usually) sided
- Single or multiple platter
- Head mechanism
  - Contact (Floppy)
  - Fixed gap
  - Flying (Winchester)

# Fixed/Movable Head Disk

- Fixed head
  - One read write head per track
  - Heads mounted on fixed ridged arm
- Movable head
  - One read write head per side
  - Mounted on a movable arm

# Removable or Not

- Removable disk
  - Can be removed from drive and replaced with another disk
  - Provides unlimited storage capacity
  - Easy data transfer between systems
- Nonremovable disk
  - Permanently mounted in the drive

# Multiple Platter

- One head per side
- Heads are joined and aligned
- Aligned tracks on each platter form cylinders
- Data is striped by cylinder
  - reduces head movement
  - Increases speed (transfer rate)

# Multiple Platters

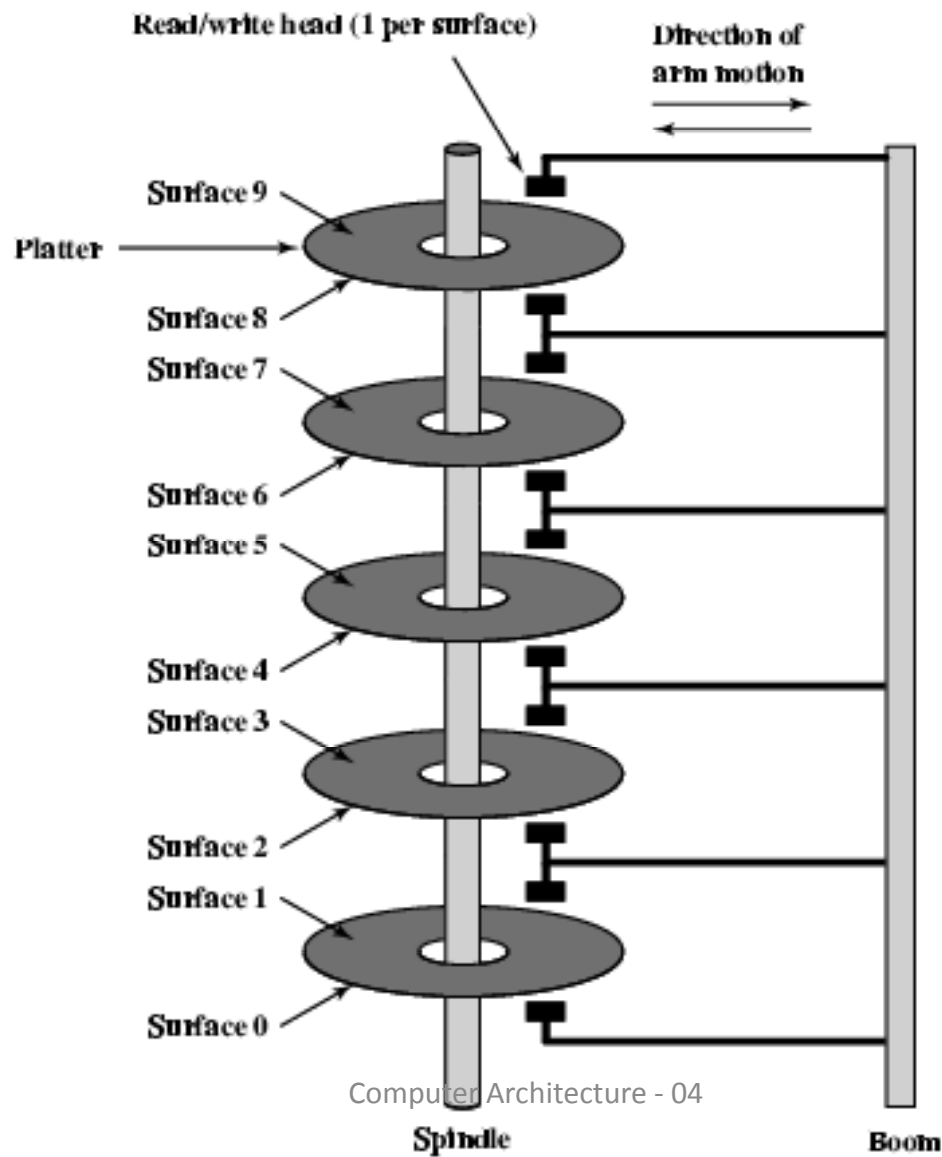

# Tracks and Cylinders

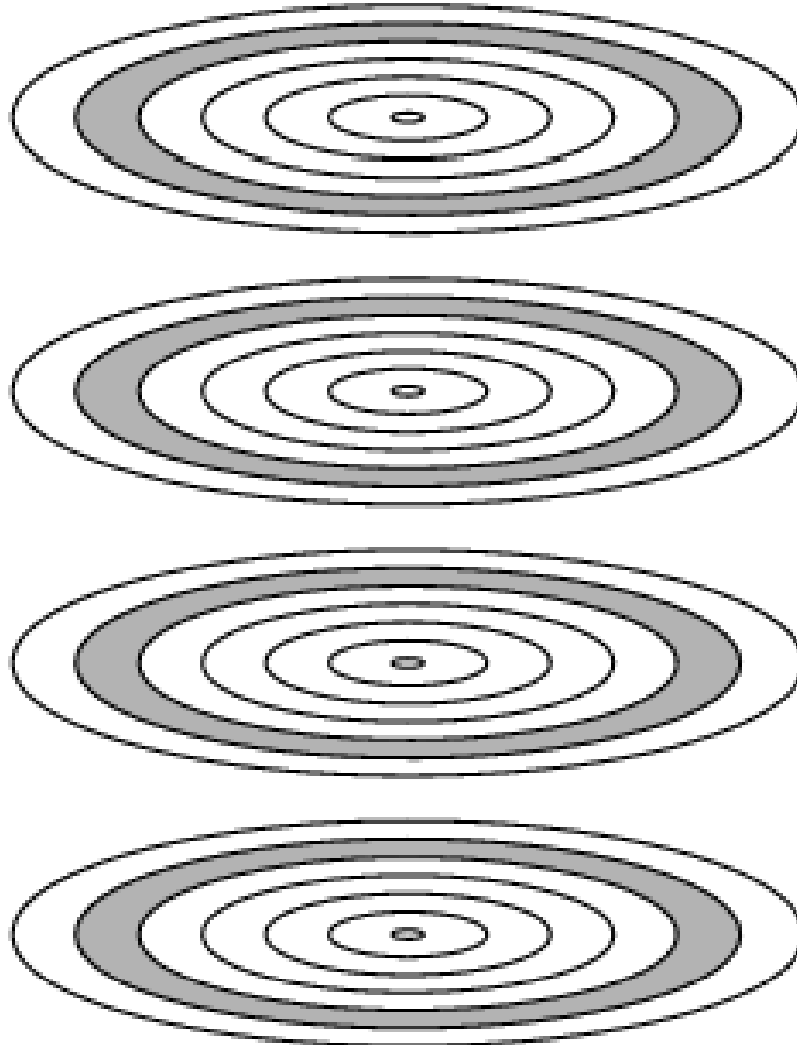



# Floppy Disk

- 8", 5.25", 3.5"
- Small capacity
  - Up to 1.44Mbyte (2.88M never popular)
- Slow
- Universal
- Cheap
- Obsolete?

# Winchester Hard Disk (1)

- Developed by IBM in Winchester (USA)
- Sealed unit
- One or more platters (disks)
- Heads fly on boundary layer of air as disk spins
- Very small head to disk gap
- Getting more robust

# Winchester Hard Disk (2)

- Universal
- Cheap
- Fastest external storage
- Getting larger all the time
  - 250 Gigabyte now easily available

# Speed

- Seek time
  - Moving head to correct track
- (Rotational) latency
  - Waiting for data to rotate under head
- Access time = Seek + Latency
- Transfer rate

# RAID

- Redundant Array of Independent Disks
- Redundant Array of Inexpensive Disks
- 6 levels in common use
- Not a hierarchy
- Set of physical disks viewed as single logical drive by O/S
- Data distributed across physical drives
- Can use redundant capacity to store parity information

# RAID 0

- No redundancy
- Data striped across all disks
- Round Robin striping
- Increase speed
  - Multiple data requests probably not on same disk
  - Disks seek in parallel
  - A set of data is likely to be striped across multiple disks

# RAID 1

- Mirrored Disks
- Data is striped across disks
- 2 copies of each stripe on separate disks
- Read from either
- Write to both
- Recovery is simple
  - Swap faulty disk & re-mirror
  - No down time
- Expensive

# RAID 2

- Disks are synchronized
- Very small stripes
  - Often single byte/word
- Error correction calculated across corresponding bits on disks
- Multiple parity disks store Hamming code error correction in corresponding positions
- Lots of redundancy
  - Expensive
  - Not used



# RAID 3

- Similar to RAID 2
- Only one redundant disk, no matter how large the array
- Simple parity bit for each set of corresponding bits
- Data on failed drive can be reconstructed from surviving data and parity info
- Very high transfer rates

# RAID 4

- Each disk operates independently
- Good for high I/O request rate
- Large stripes
- Bit by bit parity calculated across stripes on each disk
- Parity stored on parity disk

# RAID 5

- Like RAID 4
- Parity striped across all disks
- Round robin allocation for parity stripe
- Avoids RAID 4 bottleneck at parity disk
- Commonly used in network servers
  
- N.B. DOES NOT MEAN 5 DISKS!!!!

# RAID 6

- Two parity calculations
- Stored in separate blocks on different disks
- User requirement of N disks needs N+2
- High data availability
  - Three disks need to fail for data loss
  - Significant write penalty

# RAID 0, 1, 2

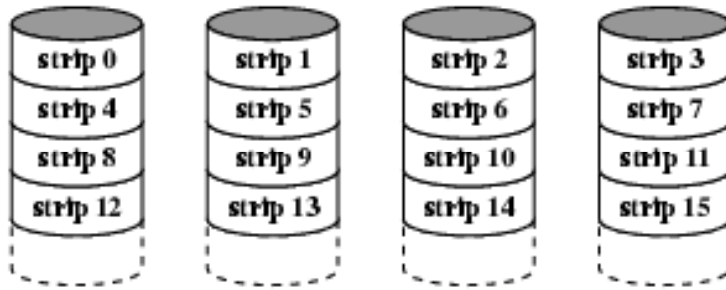

(a) RAID 0 (non-redundant)

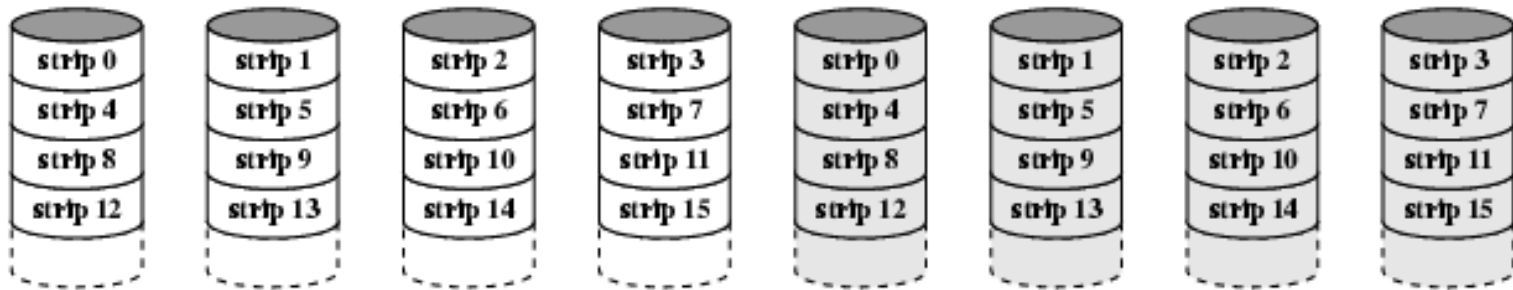

(b) RAID 1 (mirrored)

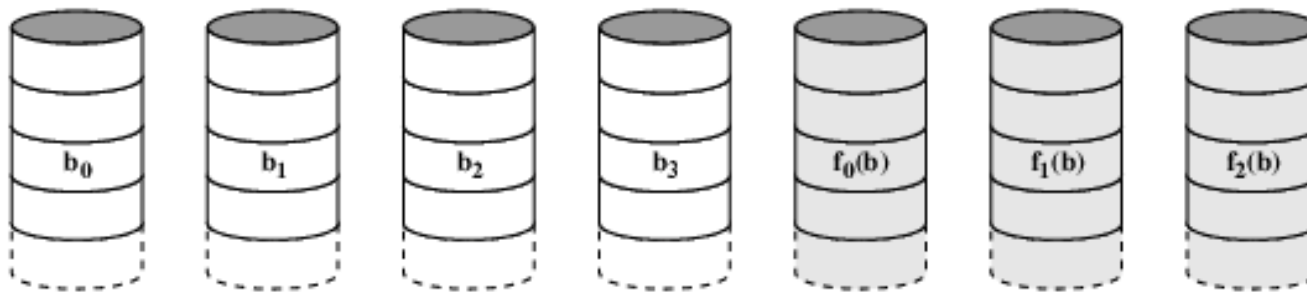

(c) RAID 2 (redundancy through Hamming code)

# RAID 3 & 4

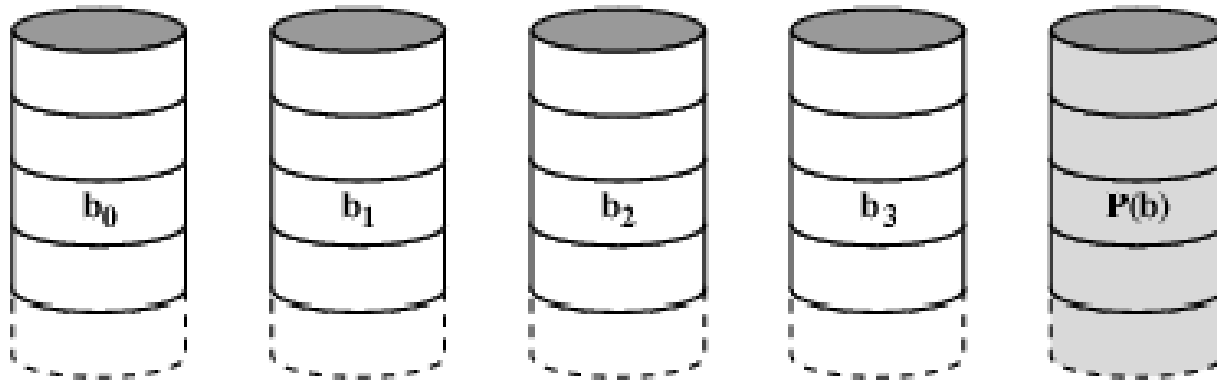

(d) RAID 3 (bit-interleaved parity)

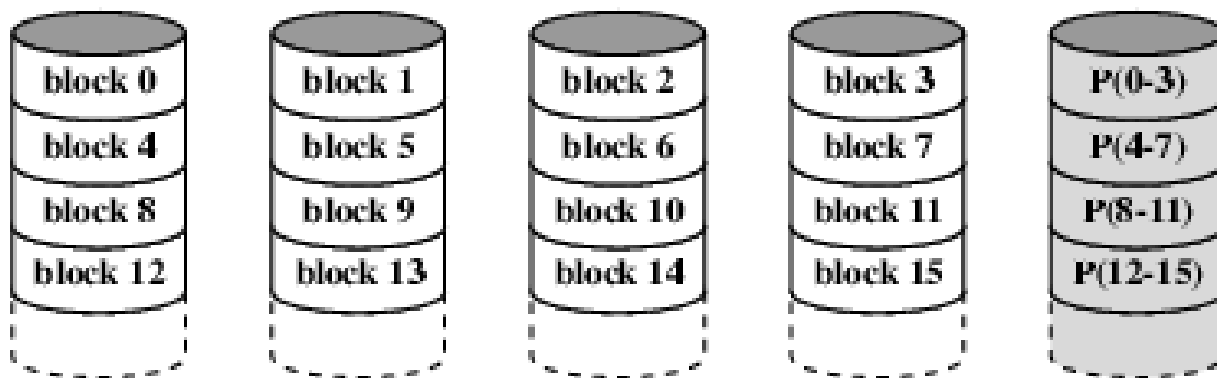

(e) RAID 4 (block-level parity)

# RAID 5 & 6

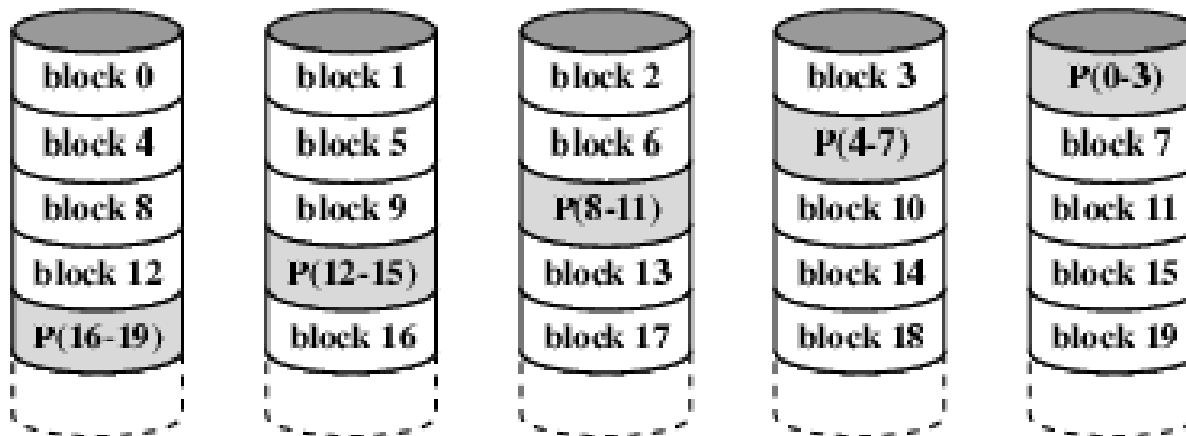

(f) RAID 5 (block-level distributed parity)

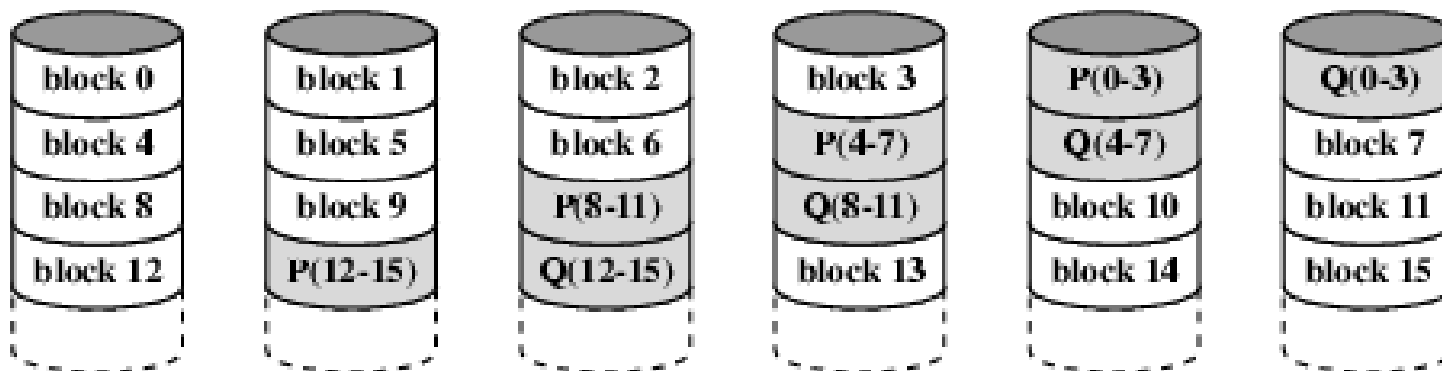

(g) RAID 6 (dual redundancy)

# Data Mapping For RAID 0

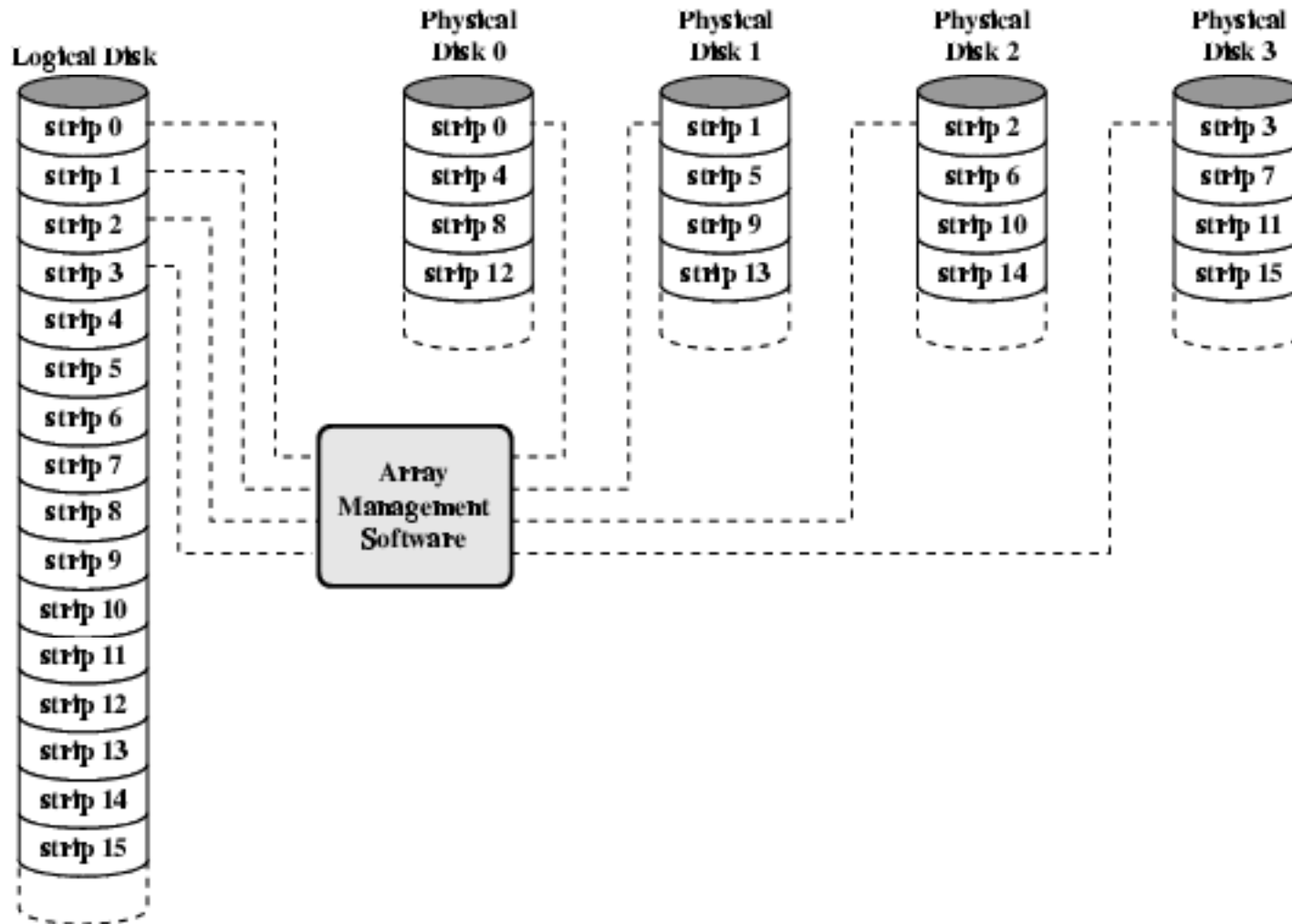



# Optical Storage CD-ROM

- Originally for audio
- 650Mbytes giving over 70 minutes audio
- Polycarbonate coated with highly reflective coat, usually aluminium
- Data stored as pits
- Read by reflecting laser
- Constant packing density
- Constant linear velocity

# CD Operation

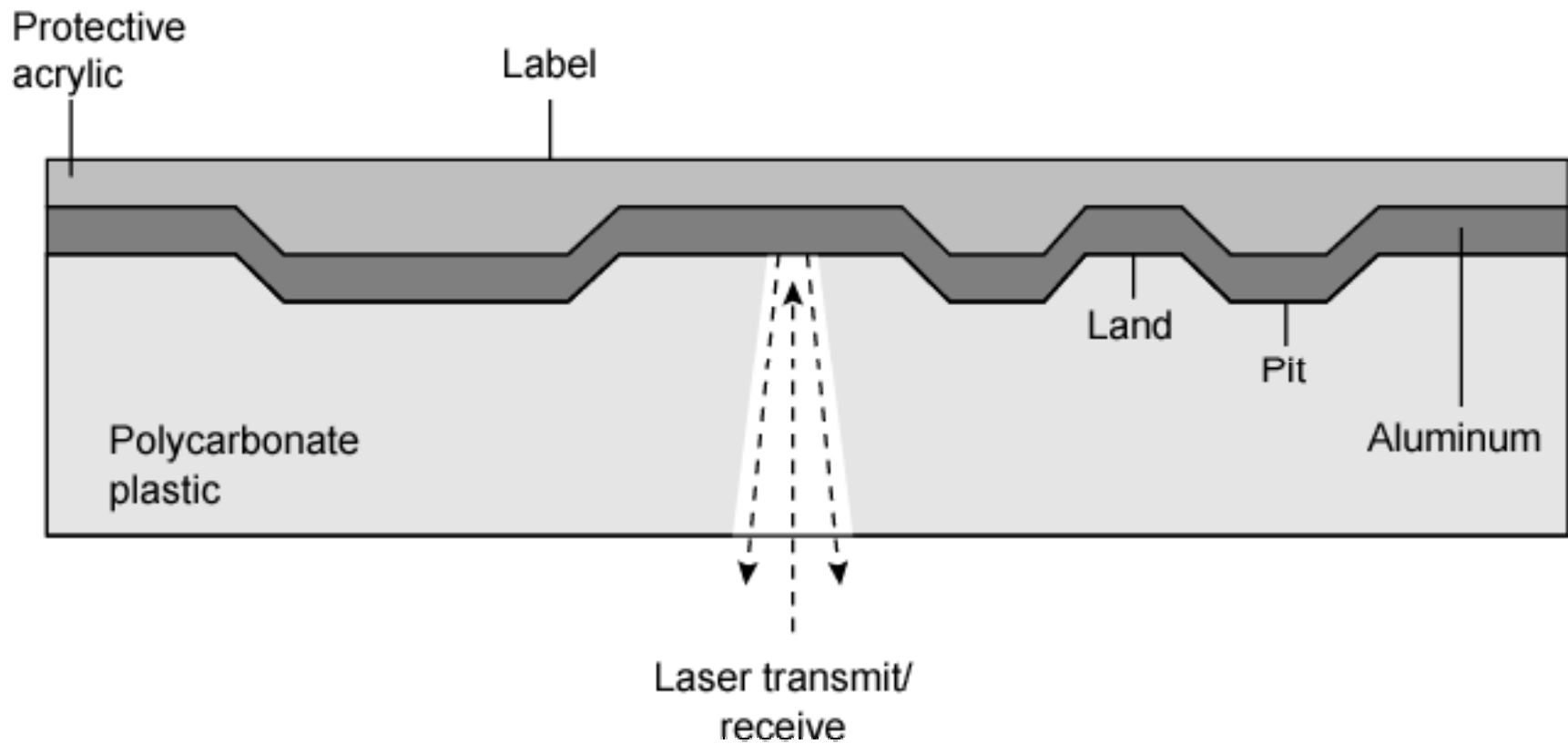

# CD-ROM Drive Speeds

- Audio is single speed
  - Constant linear velocity
  - $1.2 \text{ ms}^{-1}$
  - Track (spiral) is 5.27km long
  - Gives 4391 seconds = 73.2 minutes
- Other speeds are quoted as multiples
- e.g. 24x
- Quoted figure is maximum drive can achieve

# CD-ROM Format

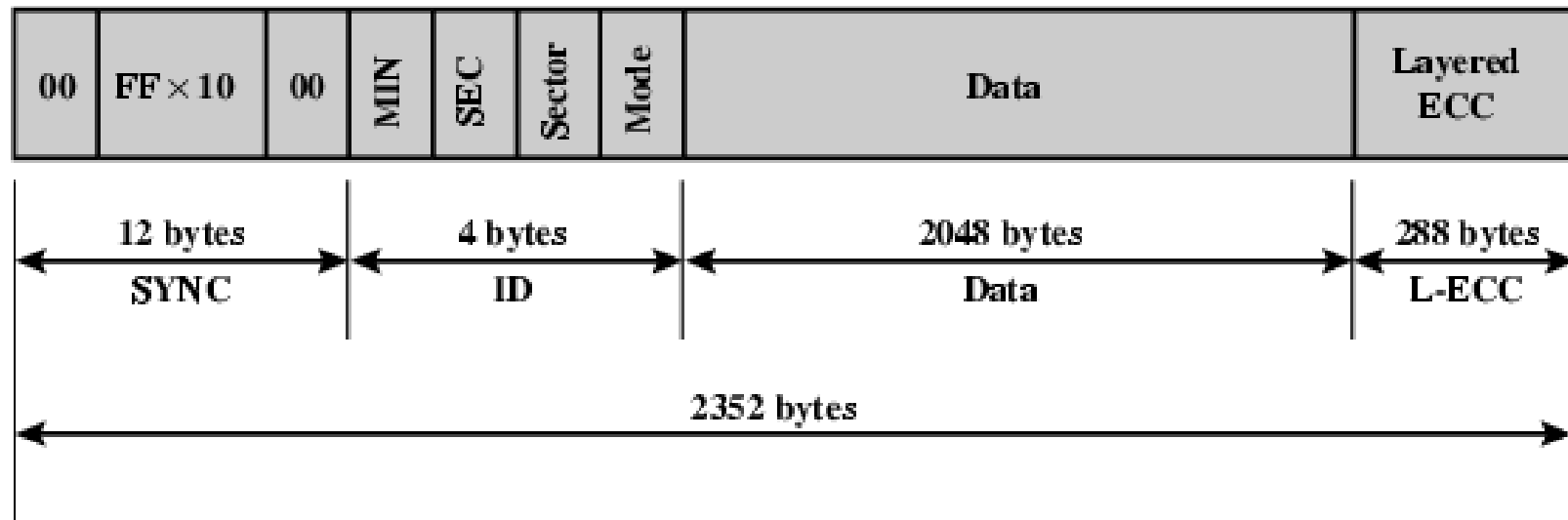

- Mode 0=blank data field
- Mode 1=2048 byte data+error correction
- Mode 2=2336 byte data

# Random Access on CD-ROM

- Difficult
- Move head to rough position
- Set correct speed
- Read address
- Adjust to required location
- (Yawn!)

# CD-ROM for & against

- Large capacity (?)
- Easy to mass produce
- Removable
- Robust
  
- Expensive for small runs
- Slow
- Read only

# Other Optical Storage

- CD-Recordable (CD-R)
  - WORM
  - Now affordable
  - Compatible with CD-ROM drives
- CD-RW
  - Erasable
  - Getting cheaper
  - Mostly CD-ROM drive compatible
  - Phase change
    - Material has two different reflectivity in different phase states

# DVD - what's in a name?

- Digital Video Disk
  - Used to indicate a player for movies
    - Only plays video disks
- Digital Versatile Disk
  - Used to indicate a computer drive
    - Will read computer disks and play video disks
- Dogs Veritable Dinner
- Officially - nothing!!!



# DVD - technology

- Multi-layer
- Very high capacity (4.7G per layer)
- Full length movie on single disk
  - Using MPEG compression
- Finally standardized (honest!)
- Movies carry regional coding
- Players only play correct region films
- Can be “fixed”

# DVD – Writable

- Loads of trouble with standards
- First generation DVD drives may not read first generation DVD-W disks
- First generation DVD drives may not read CD-RW disks
- Wait for it to settle down before buying!

# CD and DVD

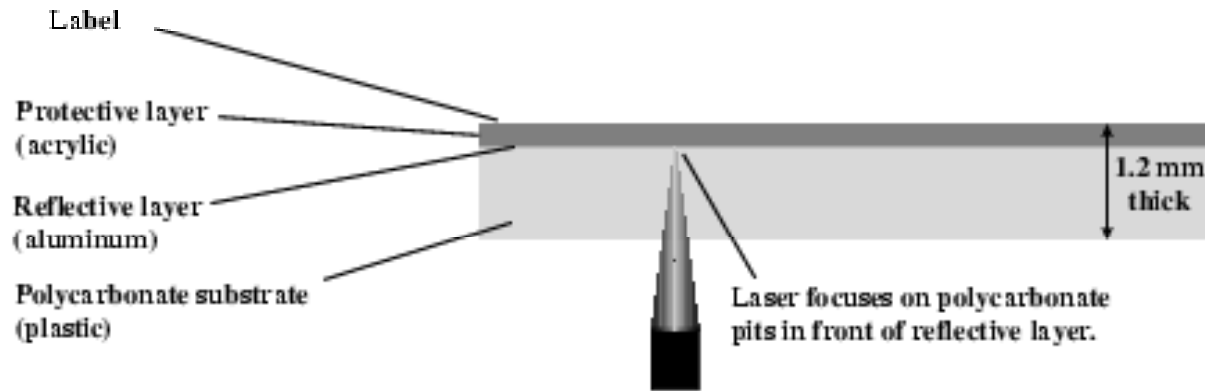

(a) CD-ROM - Capacity 682 MB

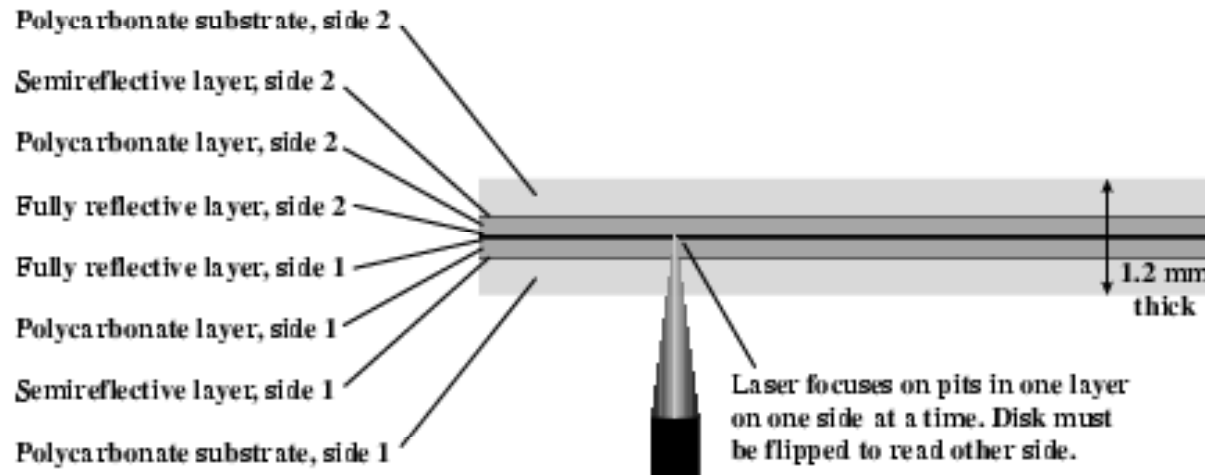

# Magnetic Tape

- Serial access
- Slow
- Very cheap
- Backup and archive

# Questions

